

Poli - poles Modelli - models

2	VSL.50_04.110L
----------	-----------------------

IT

Elettropompa sommergibile compatta e di robusta costruzione fabbricata completamente in ghisa, senza camera olio, unica tenuta meccanica posizionata sopra alla girante a diretto contatto del liquido pompato

EN

Compact and solid construction submersible pump completely made in cast iron, without oil chamber, only one mechanical seal positioned above the impeller in direct contact with the pumped liquid

FR

Pompe électrique submersible compacte et construction robuste entièrement en fonte, sans chambre à huile, seule garniture mécanique placée au-dessus de la roue en contact direct avec le liquide pompé

ES

Bomba eléctrica sumergible compacta y construcción robusta completamente de hierro fundido, sin cámara de aceite, solo sello mecánico colocado sobre el impulsor en contacto directo con el líquido bombeado

Poli - poles Modelli - models

2	VSL.50_06/09/11.110
----------	----------------------------

IT

Elettropompa sommergibile compatta e di robusta costruzione fabbricata completamente in ghisa, con camera olio interposta tra gruppo motore e gruppo pompa. Tenuta meccanica in camera olio non a diretto contatto del liquido pompato e protetta da un anello V-Ring posizionato dietro alla girante

EN

Compact and solid construction submersible pump completely made in cast iron, with oil chamber interposed between motor unit and pump unit. Mechanical seal positioned inside the oil chamber not in direct contact with the pumped liquid and protected by a V-Ring ring positioned on the back of the impeller

FR

Pompe électrique submersible compacte entièrement réalisée en fonte, avec chambre à huile intercalée entre le groupe moteur et le groupe pompe. Joint mécanique dans la chambre d'huile non en contact direct avec le liquide pompé et protégé par un anneau en V situé à l'arrière de la roue

ES

Bomba eléctrica sumergible compacta hecha completamente de hierro fundido, con cámara de aceite interpuesta entre la unidad del motor y la unidad de la bomba. Cierre mecánico en la cámara de aceite que no está en contacto directo con el líquido bombeado y está protegido por un anillo en V ubicado en la parte posterior del impulsor

VSL.50_06-09-11.110

VSL.50_04.110L



IDENTIFICAZIONE - IDENTIFICATION

Dati Idraulici Hydraulic data		Dati motore elettrico Motor data				
VSL	50	04	2	M (A)	110L	X
Vortex System / Versione leggera - Light version		06	T (A)		110	
DNm - DN outlet 50 Uscita orizzontale DN50-G 2" - Horizontal outlet DN50 - G 2"		09				
P ₂ : kW x 10		11				
Numero poli - Number of poles						
M: 1~230V - 50Hz - Monofase - Singlephase						
MA: 1~230V - 50Hz - Monofase con Galleggiante - Singlephase with float level switch						
T: 3~400 V - 50HZ - Trifase - Threephase						
TA: 3~400 V - 50HZ - Trifase con Galleggiante- Threephase with float level switch						
Grandezza motore - Motor Frame						
Costruzione speciale - Special feature						

LISTA MODELLI - RANGE OF PRODUCTS

Grandezza Motore Motor Frame	Poles	P ₂ [kW]	Alimentazione Power supply	Modelli Models	Avviamento Starting	Cavo alimentazione / segnali Power / signals cable		Camera olio Oil Chamber
						[m]	Type	
110L	2	0,4	1ph	VSL.50_04.2.M(A).110L	μF: 16	5*	H07RN-F 3G1,5	NO
			3ph	VSL.50_04.2.T(A).110L	D.O.L.	5*	H07RN-F 4G1	
110	2	0,6	1ph	VSL.502.M(A).110	μF: 20	10	H07RN-F 3G1,5	SI YES
			3ph	VSL.50_06.2.T(A).110	D.O.L.	10	H07RN-F 4G1	
		0,9	1ph	VSL.50_09.2.M(A).110	μF: 25	10	H07RN-F 3G1,5	
			3ph	VSL.50_09.2.T(A).110	D.O.L.	10	H07RN-F 4G1	
		1,1	1ph	VSL.50_11.2.M(A).110	μF: 25	10	H07RN-F 3G1,5	
			3ph	VSL.50_11.2.T(A).110	D.O.L.	10	H07RN-F 4G1	

* Per uso esterno è obbligatorio utilizzare la pompa con lunghezza cavo di 10m - vedi normativa EN 60335 - 2.41
For external use it is mandatory to use the pump with a cable length of 10m - see standard EN 60335 - 2.41

Caratteristiche costruttive - construction features

Motore asincrono in classe di isolamento F (155°C), a secco e raffreddato dal liquido circostante;

Asynchronous dry motor, insulation class F(155°C), cooled by the surrounding liquid;

Moteur asynchrone, classe d'isolation F (155°C), sec et refroidi par le liquide environnant;

Motor asincrono, aislamiento clase F (155 ° C), seco y refrigerado por el líquido que rodea.

Camera condensatore M-MA / Teleruttore TA

Capacitor chamber M-MA / Contactor TA

Chambre condensateur M-MA / Contacteur TA

Camara condensador M-MA / Contactor TA

Motore monofase con protettore termico

Singlephase motor with built in thermal protector

Moteur monophasé avec protection thermique

Motor monofásico con protector térmico

Viti	Quality
Screws	
Vis	A2
Tornillos	

O-RINGS	NBR
----------------	------------

V-Ring

Protezione albero

Shaft protection

Protection de l'arbre

protección del eje

DNm: G 2" - DN50 PN6

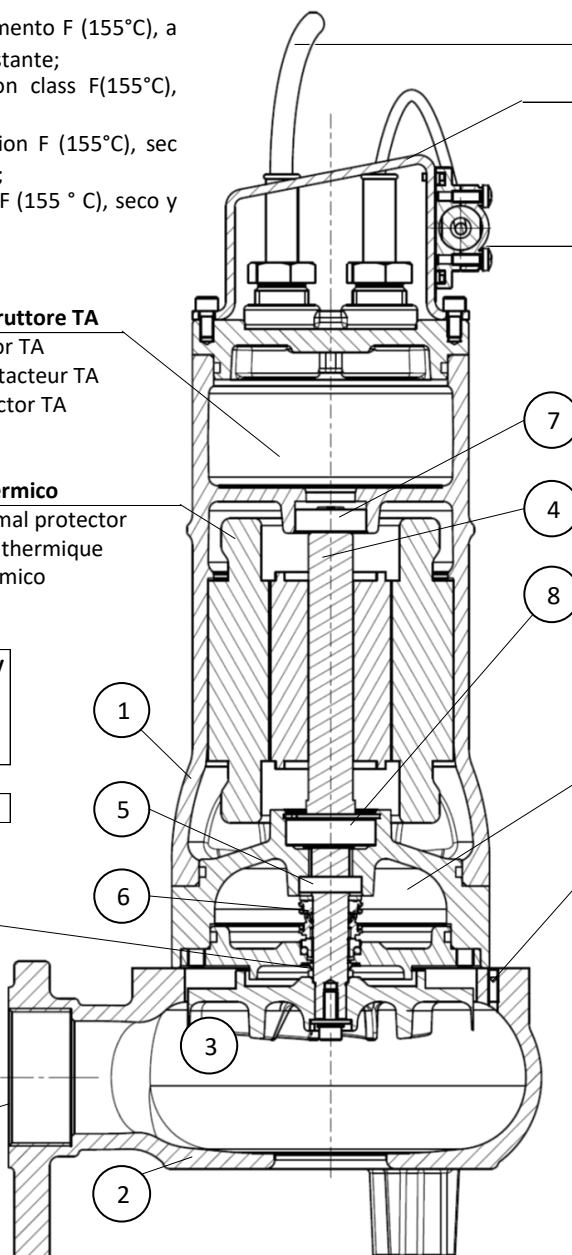

10 m - H07RN-F

Maniglia per movimentazione pompa

Handel to lift the pump

Poignée pour lever la pompe

Manejar para levantar la bomba

Fixing kit

Sistema di regolazione galleggiante

Float regulation system

Système de régulation du flotteur

Sistema de regulación del flotador

Camera olio per il raffreddamento e la lubrificazione delle tenute meccaniche

Oil chamber for the cooling and lubrication of mechanical seals

Chambre d'huile pour le refroidissement et la lubrification des garnitures mécaniques

Cámara de aceite para el enfriamiento y lubricación de sellos mecánicos

Foro di sfiato

Vent hole

Trou d'évent

Orificio de ventilación

Girante arretrata con ampio passaggio libero
Backward impeller with large free passage

Roue arrière avec grand passage libre

Impulsor hacia atrás con gran paso libre

NR.	DESCRIPTION	MATERIAL
1	Gruppo motore	Ghisa
	Motor group	Cast iron
	Groupe moteur	Fer de fonte
	Unidad de motor	Hierro
2	Corpo idraulico	Ghisa
	Pump Housing	Cast iron
	Corps de la pompe	Fer de fonte
	Cuerpo hidráulico	Hierro
3	Girante	Ghisa
	Impeller	Cast iron
	Roue	Fer de fonte
	Impulsor	Hierro
4	Albero motore	Acciaio
	Shaft	Steel
	Arbre moteur	Acier
	Eje del motor	Acero

NR.	DESCRIPTION	MATERIAL
5	Anello tenuta radiale	
	Upper sealing ring	NBR
	Bague d'étanchéité	
	Sello radial superior	
6	Tenuta mecc.	SiC / SiC
	Mech. seal	
	Haut garniture mécan.	NBR
	Sello mecánico	
7	Cuscinetto superiore	
	Top bearing	6201 - 2RS1
	Roulement supérieur	
	Cojinete superior	
8	Cuscinetto inferiore	
	Lower bearing	6203 - 2RS1
	Roulement inférieur	
	Cojinete inferior	

Caratteristiche costruttive - construction data

Costruzione Motore - Motor Frame	110	
Grado di protezione IP - IP protection	IP x8	
Classe di Isolamento - Insulation Class	F (155°C)	
Tipo di servizio - Service type	S1 Continuous / S3 Intermittent	
Avvolgimento statore - Stator winding	1~PH - Singlephase	3~PH - Threephase
	[V] 1~230V	Y / Δ 3~400/230
<input type="checkbox"/> Protezione motore - Motor Protection	Standard	Optional
<input type="radio"/> Bimetallico - Bimetal disc	<input checked="" type="checkbox"/>	<input checked="" type="checkbox"/> 130°C
<input type="radio"/> Solo su richiesta - on request only PT100	<input type="checkbox"/>	<input type="checkbox"/>
<input type="radio"/> Solo su richiesta - on request only PTC	<input type="checkbox"/>	<input type="checkbox"/>
Raffreddamento - Cooling	Dal liquido circostante - By surrounding fluid	
Camera olio - Oil chamber	Si - Yes	
Protezione Tenuta - Leakage protection	No	
Tipo girante - Impeller	Vortex	
DN mandata - Discharge	G 2"- DN 50 PN6	
Controflangia filettata - Threaded counterflange	No -	
DN aspirazione / Suction	[mm]	Ø 50
Tipo di vernice e spessore - Paint type and thickness	Standard: Vernice all'acqua - Water paint / 30µm Opaco Nero - Opaque Black	
	Optional: Epossidica - Epoxy coating / 80mm RAL 7015 - Grigio - Grey	

Limiti di utilizzo - Operating Limits

Temperatura massima liquido - Pumped fluid max temperature	[°C]	≤ 40
Densità liquido - Density	[Kg/dm ³]	~ 1
Viscosità - Viscosity	[mm ² /s]	~ 1
Contenuto di cloruri - Chlorides content	[mg/l]	< 200
PH liquido pompato - PH value		6 ÷ 12
Max. prof. Immersione - Max. Immersion depth	[m]	20
Max. contenuto solidi abrasivi - Max. abrasive solid content	[g/l]	< 1

Corretta rotazione della girante
Rotation of the impeller

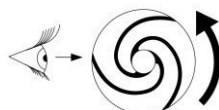

CURVA CARATTERISTICA - PERFORMANCE CURVE

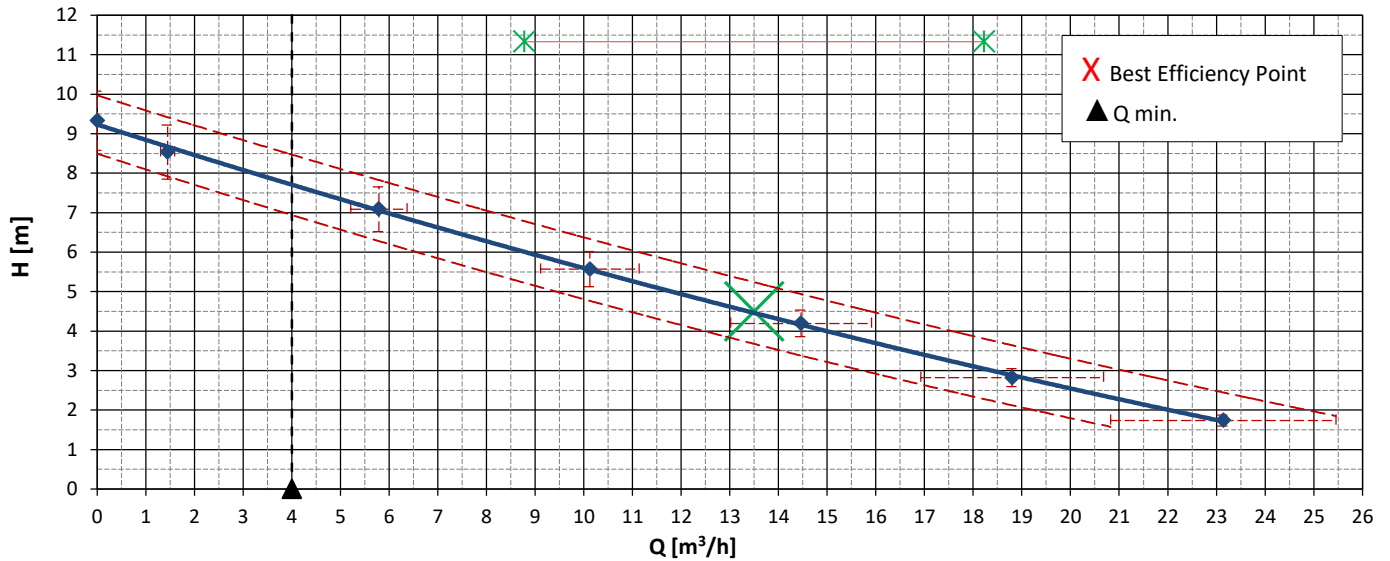

POTENZA ALL'ALBERO - SHAFT POWER

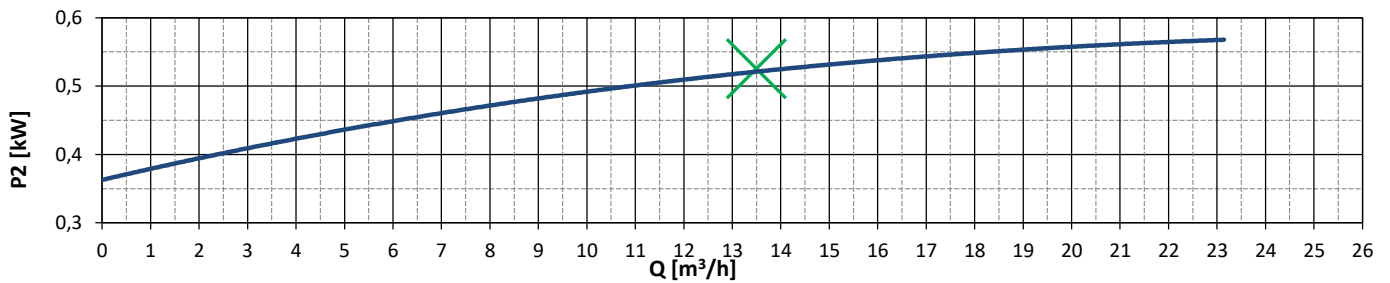

RENDIMENTO IDRAULICO - HYDRAULIC EFFICIENCY

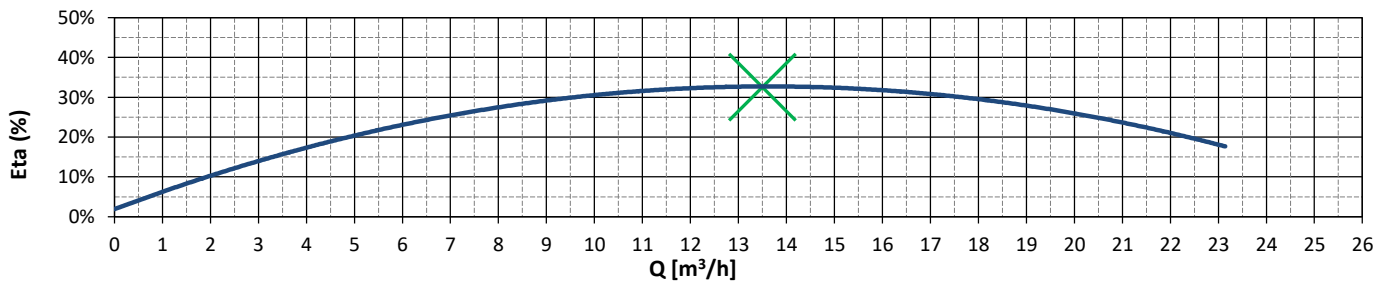

FLOW (Q)	l/min	0,0	24,1	96,4	168,7	241,1	313,4	385,7				
	l/s	0,0	0,4	1,6	2,8	4,0	5,2	6,4				
	m³/h	0,0	1,4	5,8	10,1	14,5	18,8	23,1				
HEAD (H)	m	9,3	8,5	7,1	5,6	4,2	2,8	1,7				

Dati pompa / Pump data

Potenza nominale Nominal power	(P _n)	[KW]	0,60
Potenza all'albero Shaft power	(P ₂)	[KW]	0,57
Potenza assorbita Supply Power	(P ₁)	[KW]	0,79
Fattore di potenza Power Factor	Cosφ		0,85

		Model M/MA	Model T/TA
Alimentazione Power supply	[V]	1~230-50Hz	3~400-50Hz
Avviamento Starting		25 μF	D.O.L.
Corrente Nominale Rated current	[A]	4,5	1,6
Corrente di spunto Starting current	[A]	13,5	8,0

Passaggio libero Free Passage	[mm]	Ø 50
Diametro girante Impeller diameter	[mm]	Ø 108
Peso pompa Weight	[Kg]	23,5

Galleggiante Float level switch	Optional (MA)	Optional (TA)
Cavo Cable	10m 3G1,5	10m 4G1
Nr. Avviamenti / ora Nr. Start per hour	30	

In accordo con: ISO 9906:2012 - Grade 3B (section 4.4.2)
In accordance to:

Curve per liquidi con densità/curve established for liquid with density
1kg/dm3 - viscosità/viscosity 1 mm2/s - temperatura/temperature 20°C

Dimensioni d'ingombro - overall dimensions

S Installazione mobile - Installation mobile - Installation mobile - Instalación móvil

Dimensione imballo
Packaging dimensions

Misure - Measures [mm]

A	B	C
570	250	215







FC Con piede di accoppiamento - With foot coupling - Avec pied d'assise - Con pie de acoplamiento

8FC00002 KG: 7,5

1	Supporto tubi guida da 3/4" / 3/4" guide rails bracket
2	Piede orizzontale 2" / Horizontal foot - 2"out
3	Slitta completa / Sliding bracket complete
4	Esclusi dalla fornitura / Not supplied

D	260mm
E	175mm
F	195mm

ACCESSORI - ACCESSORIES - ACCESORIES - ACCESORIOS

Descrizione - Description - Description - Descripción		Codice Code
FC	 <ul style="list-style-type: none"> - Dispositivo di accoppiamento DN50 - uscita G 2" - DN50 Coupling device - outlet 2" - Dispositif de couplage DN50 - sortie G 2" - Dispositivo de acoplamiento DN50- salida G 2" 	8FC000002
	 <ul style="list-style-type: none"> - Catena ferro zincato - galvanized Iron - Chain fer galvanisé - hierro galvanizado 	2SC000019
	<ul style="list-style-type: none"> - Catena Acciaio - Stainless steel - Cadena acier inox - acero inox 	2SC000032
TBV	 <ul style="list-style-type: none"> - Valvola di ritegno a palla filettata - Threaded valve - Vanne fileté - Válvula roscada 	G 2" 4BV000003
HF	 <ul style="list-style-type: none"> - Regolatore di livello per acque reflue - Level switch for sewage - Interrupteur de niveau pour eaux usées - Interruptor de nivel para aguas residuales 	[10 mt] 3CS000007
SHELL	 <ul style="list-style-type: none"> - Contrappeso SHELL per galleggiante - Counterweight SHELL for level switch - Cotrepoids SHELL pour interrupteur de niveau - Contrapeso para interruptor de nivel 	3CS000021
TUTOR	 <ul style="list-style-type: none"> - Sistema di guida del galleggiante per spazi ristretti - Float guidance system for confined spaces - Système de guidage à flotteur pour espaces confinés - Sistema de guiado flotante para espacios reducidos. 	3CS000020

SELEZIONE QUADRO DI CONTROLLO - CONTROL PANEL SELECTION

	Pole	Pump	Alim. [V]	P ₂ [KW]	In [A]	Start. Avv. [µF]
110L	2	VSL.50_04.2.M/MA.110L	1~230	0,4	3,5	16µF
		VSL.50_04.2.T.110L	3~400	0,4	1,2	DOL
110	2	VSL.50_06.2.M/MA.110	1~230	0,6	4,5	20µF
		VSL.50_06.2.T/TA.110	3~400	0,6	1,6	DOL
		VSL.50_09.2.M/MA.110	1~230	0,9	6,7	25µF
		VSL.50_09.2.T/TA.110	3~400	0,9	2,2	DOL
		VSL.50_11.2.M/MA.110	1~230	1,1	7,7	25µF
		VSL.50_11.2.T/TA.110	3~400	1,1	2,8	DOL



- ECH -
ELECTROMECHANICAL

1 Pump			2 Pumps			
ECH1.M-7 5EC000006	ECH1.M-14 5EC000008	ECH1.T-7 5EC000005	ECH2.M-7 5EC000030	ECH2.M-14 5EC000032	ECH2.T-7 5EC000029	
•			•			
		•			•	
•			•			
		•			•	
	•			•		
		•			•	
	•			•		
		•			•	



- ECL -
ELECTRONIC

1 Pump			2 Pumps		
ECL1.M-16 5EC000081	ECL1.T-15 5EC000083	ECL2.M-16 5EC000082	ECL2.T-15 5EC000084		
•			•		
		•		•	
•			•		
	•			•	
•			•		
	•			•	
•			•		
	•			•	
		•		•	